



### STANDARD ALUMINIUM DOORS

The aluminum door collection offers a high-quality products that will never peel-off or wear out. The doors are made of aluminum obtained through an anodization bathing process and they can be brushed, powder coated, or satin finished. Several colors are offered, from Anodized Black Matte to Stainless Steel. Over 80+ type of glass insert are available like Clear, Mirror, Acid, Smoked and Wired. While both integrated and structural handles are available as standard, the doors can be prepared for any kind of handle on the market. For further information, refer to the following pages.

#### LIST OF FINISHES





**DOOR MODELS**

**INT03**

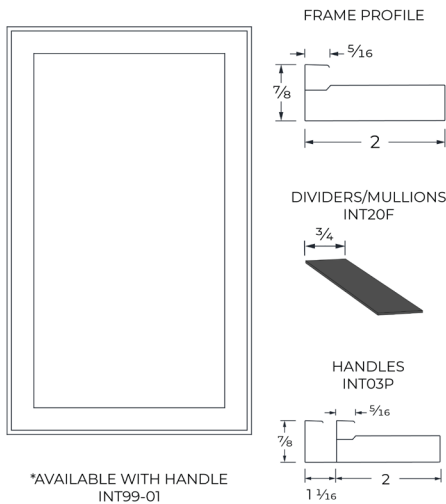

| DOOR SPECIFICATIONS |   |
|---------------------|---|
| HANDLES             | INT03P<br>INT99 (3"-4"-6"-8")                                 |
| MULLIONS            | INT20F-GLUED (HORIZ./VERT.)<br>*ONLY AVAILABLE IN AL, AB & PC |
| HINGES              | ANY STANDARD CUP HINGE  |
| GLASS INSERT        | 3MM (1/8") TO 5MM (13/64")                                    |
| MAX. WIDTH          | 48" (1219MM)  |
| MAX. HEIGHT         | 96" (2438MM)  |
| FINISHES            | AL                      SS                                    |
|                     | SZ                      AB                                    |
|                     | BB                      PC                                    |

**INT06**

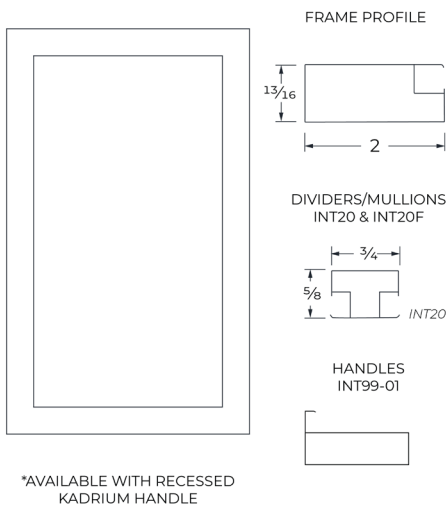

| DOOR SPECIFICATIONS |   |
|---------------------|---|
| HANDLES             | INT99-01 (3"-4"-6"-8")<br>RECESSED KADRIUM                          |
| MULLIONS            | INT20 (HORIZ./VERT.)<br>INT20F-GLUED *ONLY AVAILABLE IN AL, AB & PC |
| HINGES              | ANY STANDARD CUP HINGE  |
| GLASS INSERT        | 3MM (1/8") TO 5MM (13/64")  |
| MAX. WIDTH          | 48" (1219MM)  |
| MAX. HEIGHT         | 96" (2438MM)  |
| FINISHES            | AL                      SS  |
|                     | SZ                      AB  |
|                     | BB                      CR  |
|                     | PC  |



**INT11**

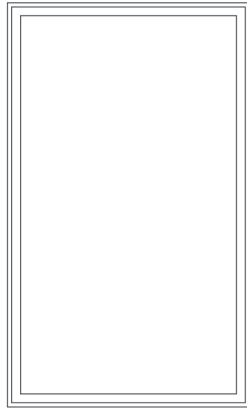

FRAME PROFILE

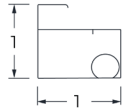

DIVIDERS/MULLIONS  
INT20F

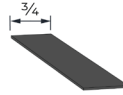

HANDLES  
PUSH-OPEN &  
INT90P



**SALICEAIR**

| DOOR SPECIFICATIONS |   |
|---------------------|---|
| HANDLES             | INT90P-GLUED<br>PUSH TO OPEN                              |
| OPENING             | TOUCH LATCH OR SOFT-CLOSE                                 |
| MULLIONS            | INT20F-GLUED (HORIZ./VERT.)<br>*ONLY AVAILABLE IN AL & PC |
| HINGES              | SALICE AIR (CONCEALED)                                    |
| GLASS INSERT        | 3MM (1/8") TO 4MM (5/32")                                 |
| MAX. WIDTH          | 24" (610MM)   |
| MAX. HEIGHT         | 84" (2134MM)  |
| FINISHES            | NICKEL  |
|                     | TITANE  |
|                     | BLACK PC  |
|                     | OTHER PC  |

SPECIFIC FINISHES FOR INT-11

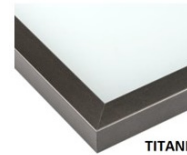

**INT12**

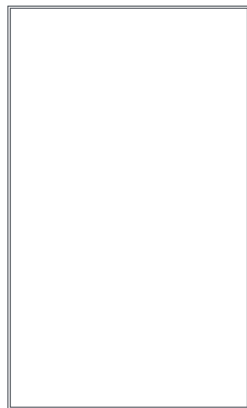

FRAME PROFILE

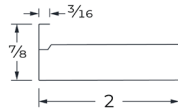

DIVIDERS/MULLIONS  
INT20F

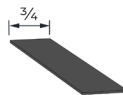

HANDLES  
INT99-01



| DOOR SPECIFICATIONS |  |
|---------------------|--|
| HANDLES             | INT99 (3"-4"-6"-8")                    |
| MULLIONS            | INT20F-GLUED (HORIZ./VERT.) AL & PC    |
| HINGES              | ANY STANDARD CUP HINGE                 |
| GLASS INSERT        | 3MM (1/8") TO 5MM (13/64") OPAQUE ONLY |
| MAX. WIDTH          | 48" (1219MM)                           |
| MAX. HEIGHT         | 96" (2438MM)                           |
| FINISHES            | AL                                     |
|                     | SS                                     |
|                     | PC                                     |



**INT15**

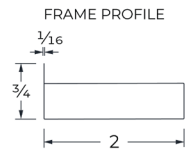

DIVIDERS/MULLIONS  
N/A



HANDLES  
INT15P

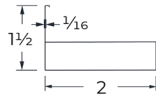

\*AVAILABLE WITH HANDLE  
INT99-01

| DOOR SPECIFICATIONS |  |    |
|---------------------|--|----|
| HANDLES             | INT15P                                 |    |
|                     | INT99 (3"-4"-6"-8")                    |    |
| MULLIONS            | N/A                                    |    |
| HINGES              | ANY STANDARD CUP HINGE                 |    |
| GLASS INSERT        | 3MM (1/8") TO 5MM (13/64") OPAQUE ONLY |    |
| MAX. WIDTH          | 48" (1219MM)                           |    |
| MAX. HEIGHT         | 96" (2438MM)                           |    |
| FINISHES            | AL                                     | SS |
|                     | BB                                     | PC |

**INT19**

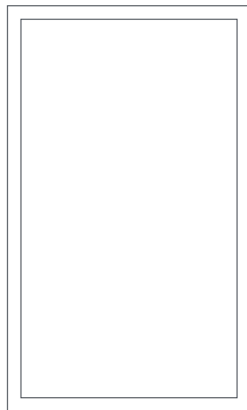

FRAME PROFILE

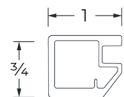

DIVIDERS/MULLIONS  
INT20F

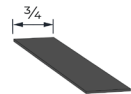

HANDLES  
PUSH-OPEN &  
INT90P



**SALICEAIR**

| DOOR SPECIFICATIONS |   |          |
|---------------------|---|----------|
| HANDLES             | INT90P-GLUED  |          |
|                     | PUSH TO OPEN  |          |
| OPENING             | TOUCH LATCH OR SOFT-CLOSE                                 |          |
| MULLIONS            | INT20F-GLUED (HORIZ./VERT.)<br>*ONLY AVAILABLE IN AL & PC |          |
| HINGES              | SALICE AIR (CONCEALED)                                    |          |
| GLASS INSERT        | 3MM (1/8") TO 4MM (5/32")                                 |          |
| MAX. WIDTH          | 24" (610MM)   |          |
| MAX. HEIGHT         | 84" (2134MM)  |          |
| FINISHES            | NICKEL  | TITANE   |
|                     | BLACK PC  | OTHER PC |

SPECIFIC FINISHES FOR INT-19

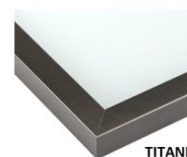
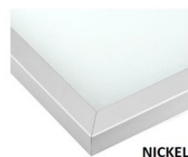



**INT27**

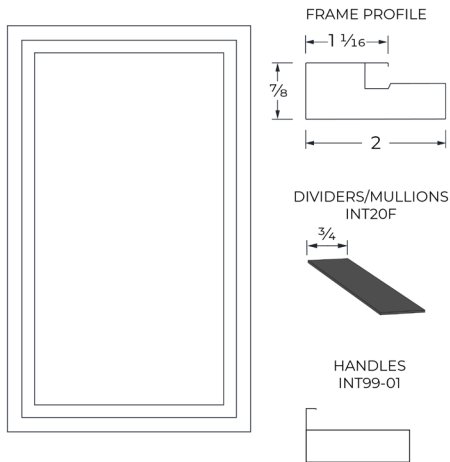

| DOOR SPECIFICATIONS |   |
|---------------------|---|
| HANDLES             | INT99 (3"-4"-6"-8")                                       |
| MULLIONS            | INT20F-GLUED (HORIZ./VERT.)<br>*ONLY AVAILABLE IN AL & PC |
| HINGES              | ANY STANDARD CUP HINGE                                    |
| GLASS INSERT        | 3MM (1/8") TO 5MM (13/64")                                |
| MAX. WIDTH          | 48" (1219MM)  |
| MAX. HEIGHT         | 96" (2438MM)  |
| FINISHES            | AL                      SS                                |
|                     | BB                      CR                                |
| PC                  |   |

**INT658**

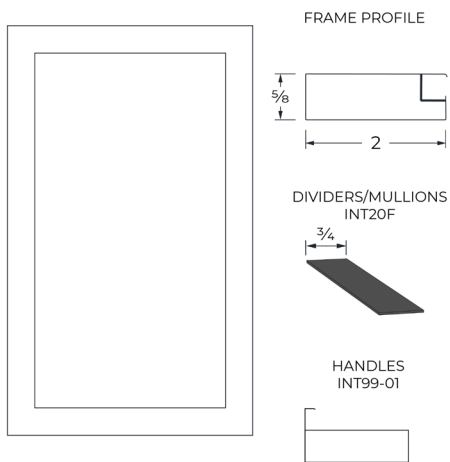

\*AVAILABLE WITH RECESSED  
KADRIUM HANDLE

| DOOR SPECIFICATIONS |   |
|---------------------|---|
| HANDLES             | INT99 (3"-4"-6"-8")   |
|                     | RECESSED KADRIUM  |
| MULLIONS            | INT20F-GLUED (HORIZ./VERT.)<br>*ONLY AVAILABLE IN AL, AB & PC |
| HINGES              | ANY STANDARD CUP HINGE  |
| GLASS INSERT        | 3MM (1/8") TO 5MM (13/64")                                    |
| MAX. WIDTH          | 48" (1219MM)  |
| MAX. HEIGHT         | 96" (2438MM)  |
| FINISHES            | AL                      SS                                    |
|                     | SZ                      AB                                    |
|                     | BB                      PC                                    |



**INT658-FL**

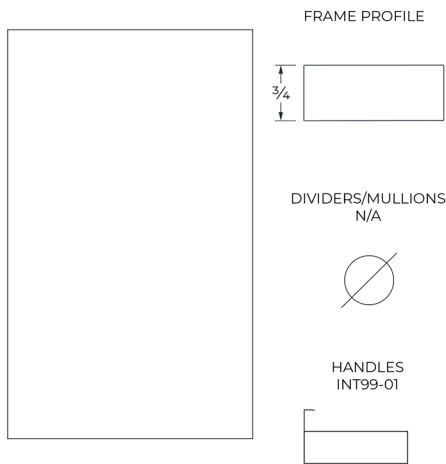

| DOOR SPECIFICATIONS |                            |    |
|---------------------|----------------------------|----|
| HANDLES             | INT99 (3"-4"-6"-8")        |    |
| MULLIONS            | N/A                        |    |
| HINGES              | ANY STANDARD CUP HINGE     |    |
| GLASS INSERT        | 3MM (1/8") TO 5MM (13/64") |    |
| MAX. WIDTH          | 48" (1219MM)               |    |
| MAX. HEIGHT         | 96" (2438MM)               |    |
| FINISHES            | AL                         | SS |
|                     | SZ                         | AB |
|                     | BB                         | PC |

**INT1258**

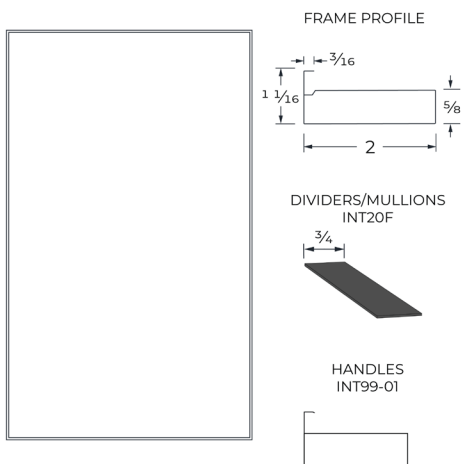

| DOOR SPECIFICATIONS |   |    |
|---------------------|---|----|
| HANDLES             | INT99 (3"-4"-6"-8")                                       |    |
| MULLIONS            | INT20F-GLUED (HORIZ./VERT.)<br>*ONLY AVAILABLE IN AL & PC |    |
| HINGES              | ANY STANDARD CUP HINGE                                    |    |
| GLASS INSERT        | 3MM (1/8") TO 5MM (13/64") OPAQUE ONLY                    |    |
| MAX. WIDTH          | 48" (1219MM)  |    |
| MAX. HEIGHT         | 96" (2438MM)  |    |
| FINISHES            | AL  | SS |
|                     | PC  |    |



**INT25**

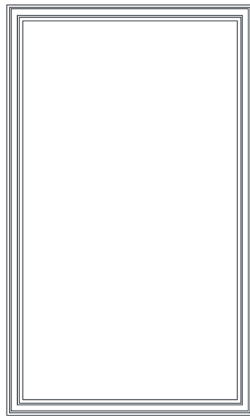

**SALICEAIR**

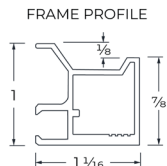

DIVIDERS/MULLIONS  
INT20F

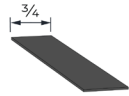

INT. HANDLE  
INT25

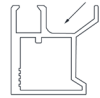

**NEW PRODUCT**

**DOOR SPECIFICATIONS**

|              |   |    |
|--------------|---|----|
| HANDLES      | INT25   |    |
| MULLIONS     | INT20F-GLUED (HORIZ./VERT.)<br>*ONLY AVAILABLE IN AL & PC |    |
| HINGES       | SALICE AIR (CONCEALED)                                    |    |
| GLASS INSERT | 3MM (1/8") TO 5MM (13/64")                                |    |
| MAX. WIDTH   | 24" (610MM)   |    |
| MAX. HEIGHT  | 84" (2134MM)  |    |
| FINISHES     | AL  | AB |
|              | BG  | PC |

**INT30**

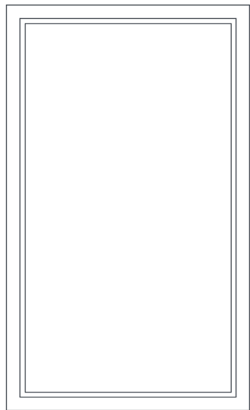

**SALICEAIR**

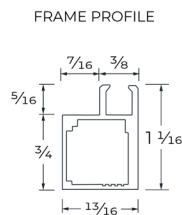

DIVIDERS/MULLIONS  
INT20F

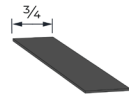

INT. HANDLE  
INT99 & INT31

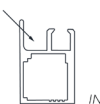

**NEW PRODUCT**

**DOOR SPECIFICATIONS**

|              |   |    |
|--------------|---|----|
| HANDLES      | INT99 (3"-4"-6"-8")<br>INT31 (1 TO 4 SIDES)               |    |
| MULLIONS     | INT20F-GLUED (HORIZ./VERT.)<br>*ONLY AVAILABLE IN AL & PC |    |
| HINGES       | SALICE AIR (CONCEALED)                                    |    |
| GLASS INSERT | 3MM (1/8") TO 5MM (13/64")                                |    |
| MAX. WIDTH   | 24" (610MM)   |    |
| MAX. HEIGHT  | 84" (2134MM)  |    |
| FINISHES     | AL  | AB |
|              | PC  |    |

\*CAN BE COMBINED WITH THE HANDLES OF INT31



**INT31**

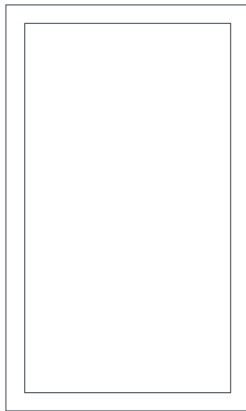

FRAME PROFILE

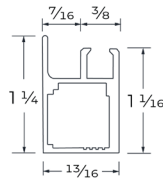

DIVIDERS/MULLIONS  
INT20F

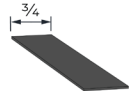

INT. HANDLE  
INT31

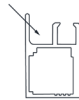

**SALICEAIR**

**NEW PRODUCT**

**DOOR SPECIFICATIONS**

|              |                             |    |
|--------------|-----------------------------|----|
| HANDLES      | INT31 (1 TO 4 SIDES)        |    |
|              | INT30 (1 TO 4 SIDES)        |    |
| MULLIONS     | INT20F-GLUED (HORIZ./VERT.) |    |
|              | *ONLY AVAILABLE IN AL & PC  |    |
| HINGES       | SALICE AIR (CONCEALED)      |    |
| GLASS INSERT | 3MM (1/8") TO 5MM (13/64")  |    |
| MAX. WIDTH   | 24" (610MM)                 |    |
| MAX. HEIGHT  | 84" (2134MM)                |    |
| FINISHES     | AL                          | AB |
|              | PC                          |    |

\*CAN BE COMBINED WITH THE INT30 PROFILE







GLASS INSERTS

TRANSLUCENT GLASSES



ACID WASH - 4MM



ACID WASH EXTRA CLEAR (LOW IRON) 4MM



AQUALITE - 4MM



CLEAR - 3/4/5MM



DELTA MATTE - 4MM



DIAMANTE - 4MM



EXTRA-CLEAR (LOW IRON) - 4MM



EXTRA-CLEAR BI-CANNES - 4MM



EXTRA-CLEAR LINEN - 4MM



EXTRA-CLEAR STRUCTURE - 4MM



FLUTEX CLEAR - 4MM



FLUTEX MATTE - 4MM



GLUE CHIP CLEAR - 4MM



GOTHIC - 4MM



KRISET - 4MM



MASTER SQUARE - 4MM



SECTION 3

DOOR STYLES & FINISHES



ROBAX CLEAR - 4MM



SATIN PLEXI - 3MM



SCREEN - 4MM



SMOKED BRONZE - 4MM



SMOKED BRONZE SATIN - 4MM



SMOKED GREY - 4/5MM



SMOKED GREY BI-CANNES - 4MM



SMOKED GREY LINEN - 4MM



SMOKED GREY SATIN - 4MM



SMOKED GREY STRUCTURE - 4MM



CORDUROY - 4MM



LISTRAL - 4MM

**NEW PRODUCT**

**NEW PRODUCT**



**OPAQUE GLASSES**

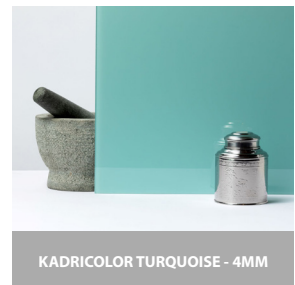
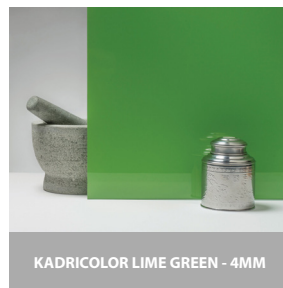
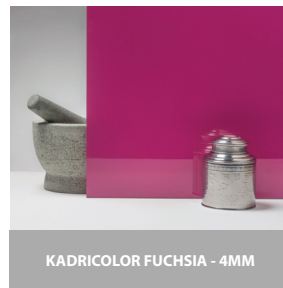
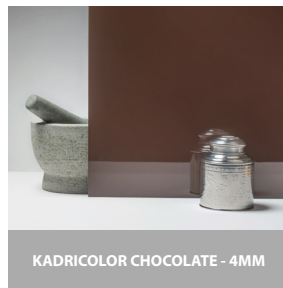
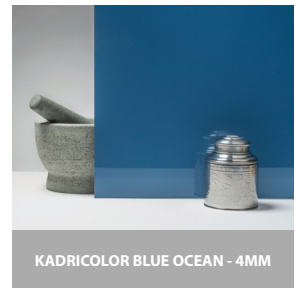
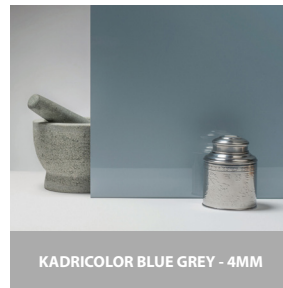
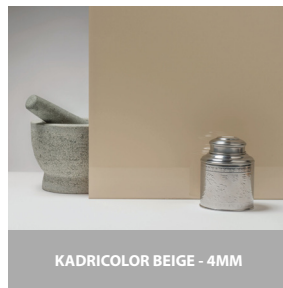
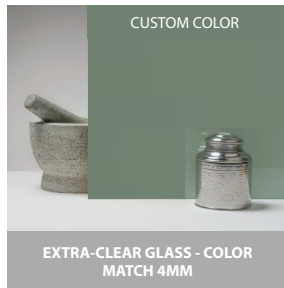



MIRRORS



ANTIQUÉ MIRROR - 5MM

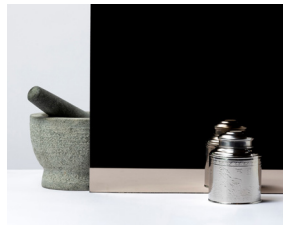

BRONZE MIRROR - 5MM



BRONZE SATIN MIRROR - 4MM



CLEAR MIRROR - 3/4/5MM



CLEAR SATIN MIRROR - 4MM



SMOKED GREY MIRROR - 4MM



SMOKED GREY SATIN MIRROR - 4MM



SMOKED GREY STRUCTURE MIRROR - 4MM



OTHER INSERTS



DEKTRON ARGA - 4MM



DEKTRON AURA 15 - 4MM



DEKTRON BROMO - 4MM



DEKTRON EDORA - 4MM



DEKTRON HALO - 4MM

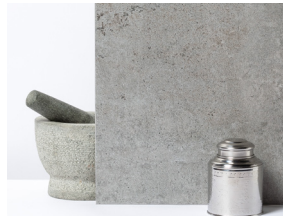

DEKTRON KRETA - 4MM



DEKTRON LAOS - 4MM



DEKTRON LAURENT - 4MM



DEKTRON LUNAR - 4MM

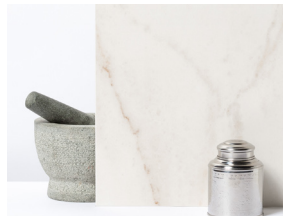

DEKTRON REM - 4MM



DEKTRON SIRIUS - 4MM



DEKTRON TRILIUM - 4MM



**MULLIONS-DIVIDERS OPTIONS**

**MULLION OPTIONS**



2 TILES - HORIZONTAL



3 TILES - HORIZONTAL



4 TILES - HORIZONTAL



5 TILES - HORIZONTAL

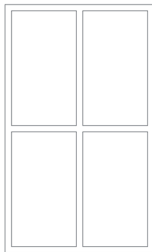

4 TILES  
VERTICAL/HORIZONTAL



6 TILES  
VERTICAL/HORIZONTAL



8 TILES  
VERTICAL/HORIZONTAL



10 TILES  
VERTICAL/HORIZONTAL

**DIVIDER OPTIONS**

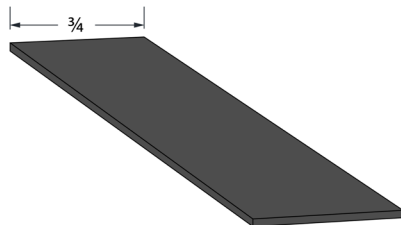

INT20 (ASSEMBLED)

OR

INT20F (GLUED)



**HANDLES**

**STANDARD OPTIONS**

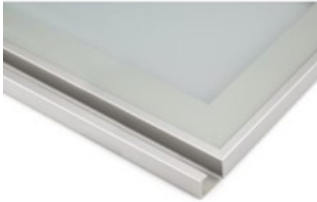

INT03P

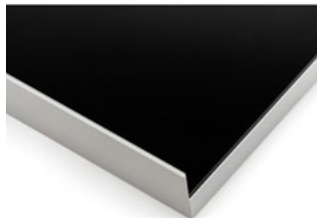

INT15P



INT99P



INT90P



RECESSED KADRIUM

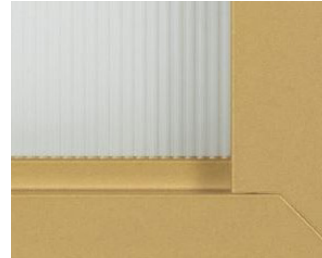

INT31

**INTEGRATED BACK HANDLE OPTIONS**

OPTION 1

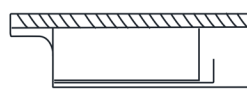

OR

OPTION 2

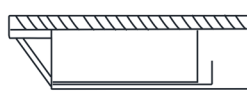



**HINGES**

Large frames are bored for standard European cup hinges (35mm, 45mm pilot hole) with a margin of 4mm, while narrow frames are bored for 95° and 120° hinges. Salice Air hinges are also an option for narrow frames but are specific to certain door models.

**LARGE FRAME**



110° CLIP TOP BLUMOTION

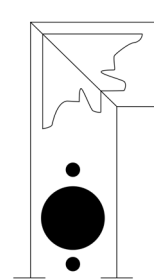

**NARROW FRAME**



#71M950A180

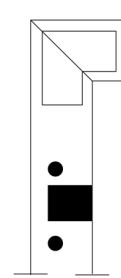

OR

**SALICEAIR**



SALICE AIR (CONCEALED)

